



Catalogue

2024

Café Racer



TECEx RoHS

Versions

3

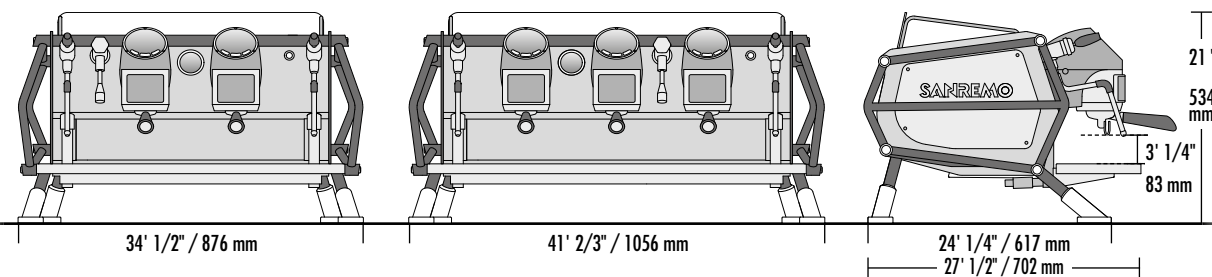

2 group CR

- 2 steam taps
- 1 water tap
- 1 one-cup filter holder
- 2 two-cup filter holders

3 group CR

- 2 steam taps
- 1 water tap
- 1 one-cup filter holder
- 3 two-cup filter holders



CE

MULTIBOILER SYSTEM

Sanremo Café Racer multiboiler system ensures a new level of thermal precision thanks to the 4 points of temperature PID control.

Technical data		2 group	3 group
voltage	V	220-240 1N / 380-415 3N	
max input boiler/steam boiler's resistor power	kW	6.9 / 3.5	8.1 / 3.5
		7.6 / 4.5	8.4 / 4.5
steam boiler capacity	lt	8	10
external pump power	kW	0.160	0.160
preheating boiler capacity	lt	1.0	1.5
preheating boiler resistance power	kW	1.0	1.5
cup-heater power	kW	0.16	0.20
units boiler capacity	lt	1.0	1.5
units boiler resistance power	kW	1.6	2.4
net weight	lb / kg	214 / 97	265 / 120
gross weight (with shipping crate)	lb / kg	333 / 151	388 / 176

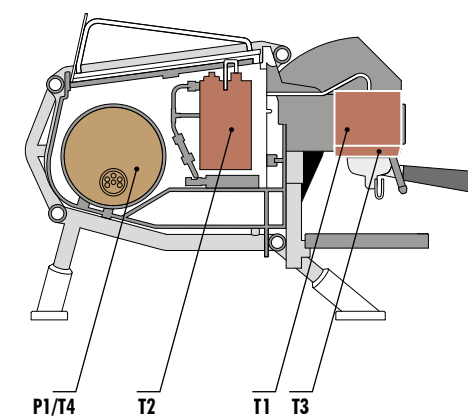



ENERGY SAVING SYSTEM

Component insulation and smart electronics for maximum energy efficiency



VOLUMETRIC PUMP PERFORMANCE

The unique 300 l/h pump guarantees constant pressure in all conditions of machine use

HIGH PERFORMANCE FLOWMETER VOLUMETRICS

For an accurate and precise coffee dose in the cup

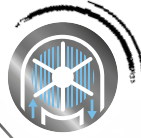

Take a ride, explore it's soul



POWER DRY STEAM

Low additional liquid during the milk steaming



EASY SERVICE

Fast access to the internal parts for quick and easy technical service



Quick setting of the individual groups

EVERYTHING UNDER CONTROL

System digital display to provide visibility of all working parameters

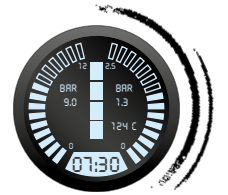

HEART OF STEEL

For maximum thermal stability:

- Groups in AISI 316L, weight 17.6 lb / 8 kg each
- Portafilters AISI 316
- Boilers AISI 316

ADJUSTABLE HEIGHT WORK SURFACE

Innovative Sanremo "All in one" suspension system that allows cups of different shapes and heights (adjustable from 3' 2/4" to 5' 3/4" / from 85 to 150 mm)



SOFT PRE-INFUSION

Flowactive System: for precise control of the water flow and pre-infusion time

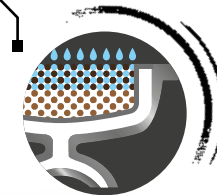

Café Racer, born to run
Link to the website

Characteristics



AISI 316L STEEL GROUPS WITH 17.6 lb / 8 kg PURE STEEL
Exclusive Sanremo design ensure exceptional thermal stability and maximum resistance to oxidation and lime scale.



AISI 316 STAINLESS STEEL FILTER HODER WITH "COMPETITION FILTER"
Exclusive Sanremo design, with shape and volume designed to capture the best coffee aromas and fragrances.



AISI 316L STAINLESS STEEL FREE MOTION STEAM TAPS
Flexible control system for producing and dispensing steam.



AISI 316L STAINLESS STEEL STEAM WAND "COOL TOUCH"
Anti-burning feature even in conditions of prolonged use, fitted with "Latte Art" high-performance steam terminals.



PROGRAMMABLE ELECTRONIC PRE-INFUSION
Allows control with 0.1 second tolerance of the flow of water that wets the coffee bed, with programming of 4 different profiles for each group.



INDEPENDENT ADJUSTMENT OF THE PID INFUSION WATER TEMPERATURE
Precision setting (gradient ± 0.5 °C with measured constancy lower than 0.2°C).



SYSTEM DISPLAY
Visibility of all the machine functions: temperatures, pressures and levels.



COFFEE UNIT SINGLE DISPLAY
Control of all coffee extraction parameters.



MIXED INFUSION HOT WATER FOR TEA AND HERBAL TEAS
Instantaneous mixing of fresh water and steam for a better chemical and organoleptic quality.



HIGH PERFORMANCE VOLUMETRIC PUMP 300 l/h
Pressure stability also with prolonged and contemporary use of more than one group.



HIGH PERFORMANCE FLOWMETER VOLUMETRICS
For an accurate and precise coffee dose in the cup.



STEAM CONTROL ADJUSTABLE ELECTRONIC PRESSURE SWITCH
Sensor with 0.02 bar precision that allows the chosen pressure and steam in the boiler to be kept constant in all conditions of use.



PROGRAMMABLE CUP WARMER TEMPERATURE
Allows the cups to be kept at the optimum temperature in the most different climatic conditions.



ELECTRONIC AUTO-LEVEL
Through an electronic level probe the boiler is automatically filled and maintained to the right filling level.



LED LIGHTING OF THE WORK AREA
Allows efficient working in any condition of environmental lighting.



AUTO-DIAGNOSIS, STATISTICAL DATA, SCHEDULED MAINTENANCE
Maintenance can be scheduled according to litres or number of coffees dispensed.



AUTO-ON, AUTO-OFF AND DAY-OFF FUNCTION
Programmable on-off timer for each day and/or daily timetables.



AUTOMATIC CLEANING CYCLE
Process for coffee groups cleaning.



BOILER WATER REGENERATION
Ensures resetting of the optimum chemical characteristics of the water and correct mineralisation.



GROUP FLUSHING
With a simple pressure of the button a small quantity of water is dispensed to allow the group to be always clean.

Optional



STAINLESS STEEL NAKED FILTER HODERS



HIGH POWER STEAMER TERMINAL
(bigger holes diameter)



EXTERNAL VOLUMETRIC PUMP



ENHANCED RESISTANCE

NAKED

✓ Transparent side and back panels

Available in 2 finishes:
black and steel, 
both available with some components*
in black or red.

● ●
* rings, bolts, feet, boiler insulation



FREEDOM

✓ Coloured side and back panels with the rear-lit logo

Available in 2 finishes:
black and steel, 
both available with some components*
in black or red.

● ●
* rings, bolts, feet







CUSTOM

Welcome to the Custom world of the Cafe Racer, huge creative potential and expression through customization. Some versions have become real icons. Chose your style and create your own unique Cafer Racer.

Renegade



handmade finishes [

-  Dark green
-  Oxidized copper
-  Brown leather
-  Polished brass
-  Oxidized brass



_ White & Wood Standard

_ CUSTOM

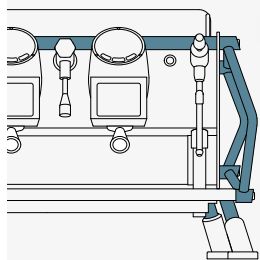

8



- Matt white**
- Natural oak**
- Stainless steel**
- Natural oak**

_ White & Wood Slim

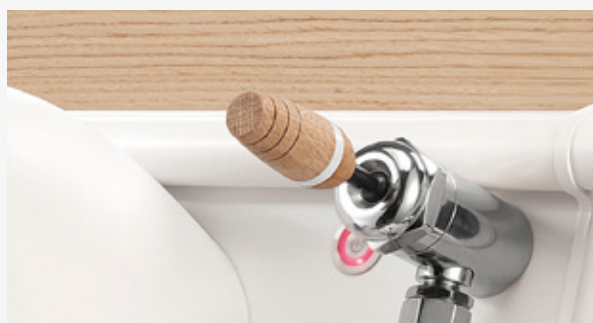
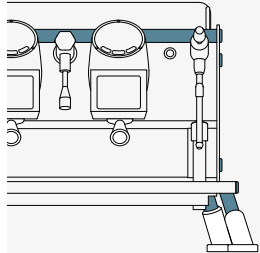

_ Racing

_ CUSTOM



9

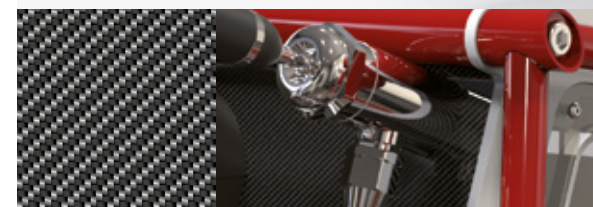

- Gloss red**
- Matt white**
- Carbon**
- Stainless steel**

_ Dolomiti



- Matt black**
 - Black steel**
 - Black leather**
 - Stainless steel**
- hand-sewn*

_ Black & White

_ CUSTOM



Matt white
 Stainless steel

_ Full White



_ Blue

_ CUSTOM



Matt blue

_ Fuchsia



Matt red

